

Nanjing SiSiB Silicones Co., Ltd.
Add: Guanghua Science & Technology Industrial Zone,
No. 104 Guanghua Road, Nanjing 210007, China
Phone: +86-25-5859-9930, 9931, 9932
Fax: +86-25-5859-9935
Email: sales@SiSiB.com
www.SiSiB.com www.PCC.asia

SiSiB SILICONES

A part of SINOPCC group.



*Formulating
RTV Silicone Sealants*

SiSiB SILICONES
A part of SINOPCC group.



SISIB
SILICONES
西斯博有机硅

SiSiB SILICONES

SiSiB SILICONES, a part of SINOCC group established in 1989, is one of the leading manufacturers in silicone industry, focusing on the development and manufacture of silanes and silicones.

Strategically positioned within the silicone supply chain, SiSiB SILICONES provide a comprehensive range of performance-enhancing products and solutions to meet the need of customers. These include silanes and siliconates, silicone fluids, silicone emulsions, silicone rubber, silicone gum and fumed silica.

Today our products are used successfully throughout the world in the adhesives and sealants, agriculture, artificial marbles, building protection, coatings & paints, fillers & pigments, foundries, fiber glass, leather & textile, lubricants, personal care, pharmaceuticals, plastics & thermoplastics, polyurethane foam, rubber & tyre, wires & cables.

■ Why select SiSiB SILICONES?

- Strong silane and silicone manufacturing capabilities built over 30+ years history.
- Flexible manufacturing facility able to handle kilograms to thousands of tons per years.
- Rapid and professional process development and scale-up capabilities.
- Offer tailored options while adhering to high quality and safety standards.



INTRODUCTION

Silicone Sealants have been an important and integral part of the sealants market for more than 50 years. One of the most popular subclasses of silicone sealants is RTV (room temperature vulcanizing) product. RTV silicone products are formulated from relatively low molecular weight linear polymers. A crosslinking reaction begins at the time the product is put into use. These crosslinking reactions occur at room temperature, hence the term "RTV", and they are generally moisture-curing reactions.

This product portfolio comprises various high quality base materials for highly elastic one-component sealants.

Component	Chemical	Function
Base Polymer	OH Polymers, PF1070 series.	Molecule backbone.
Plasticizer	PDMS Silicone Fluid, MF2010 series.	Adjust extrudability.
Crosslinkers	Acetoxy, Alkoxy and Oximino Silanes.	Crosslinking of the polymeric component.
Fumed Silica	Hydrophobic and Hydrophilic.	Thixotropic reinforcing agents, adjustments of viscosity and mechanical properties.
Adhesion Promoters	Silane Coupling Agent.	Enhance adhesion
Catalyst	OrganoTin, DBTDL and DBTDA.	Cure the network and control the rate of cure.

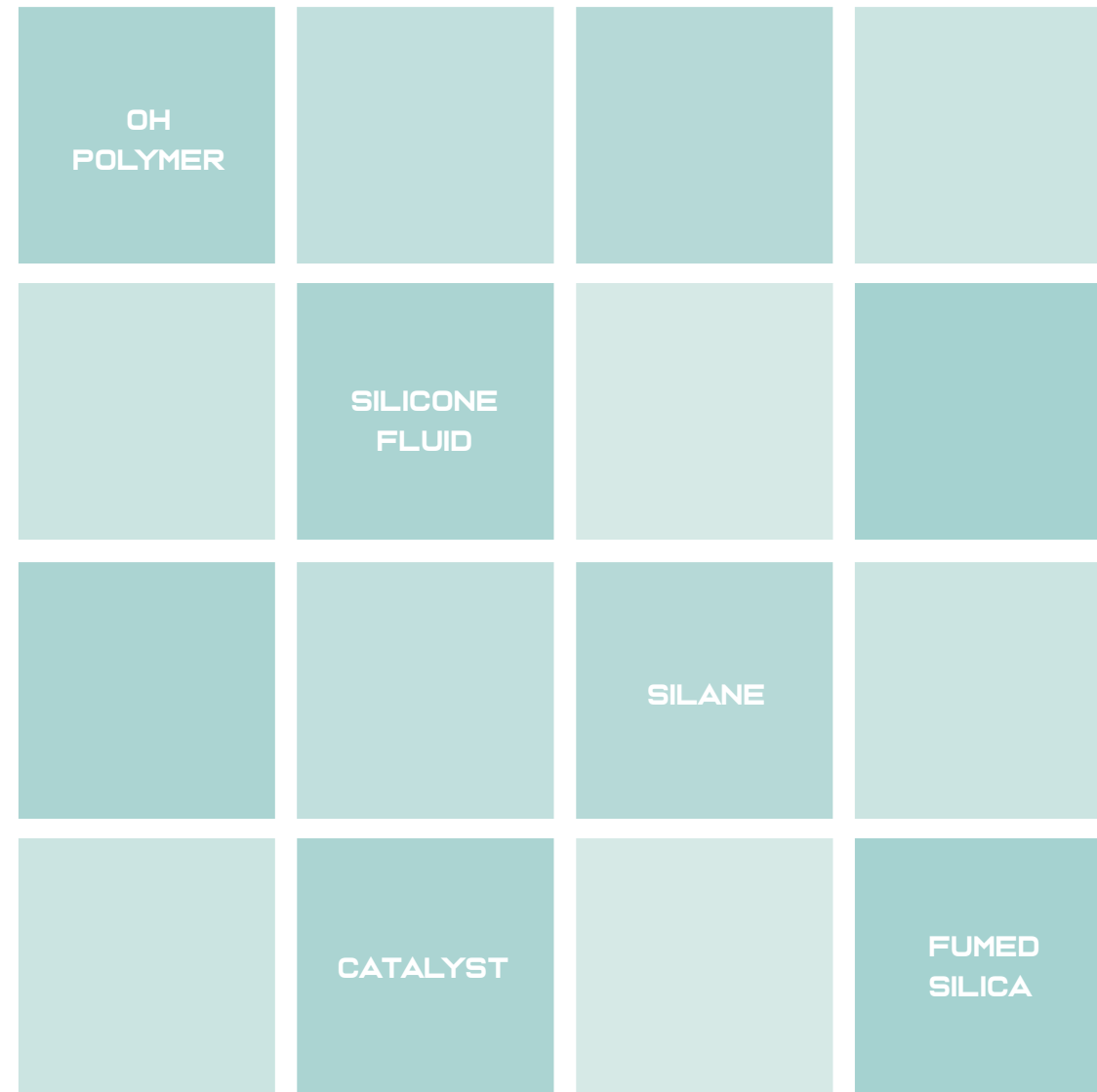

SiSiB SILICONES

BASE POLYMER

PLASTICIZER

CROSSLINKER

FUMED SILICA

ADHESION PROMOTER

CATALYST

BASE POLYMER

The fundamental building block of a silicone sealant is polymeric siloxane. This is often represented by Silanol end-capped Polydimethylsiloxane.

The silanol (-OH) terminated silicone polymer is the basis for the formulation of one component, moisture curing RTV silicone sealants, and two-component, condensation curing RTV silicone compounds.

These siloxanes polymers are available in wide range of viscosities.

SiSiB® PF1070 OH polymer is intermediate and high viscosity silanol terminated fluids, 750–100,000 cSt. They are recommended for formulating silicone RTV systems that incorporate reinforcing and extending fillers.

OH Polymer PF1070 can be cured with usual condensation crosslinkers such as alkoxy silanes, acetoxy silanes, oxime silanes and epoxy silanes in connection with catalysts.

SiSiB® PF1070
OH Polymer [CAS 70131-67-8]

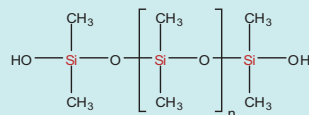

Product	Appearance	Viscosity (25°C)	Volatile (%)
SiSiB® PF1070-750	Transparent liquid	750 cSt	Max. 1.5
SiSiB® PF1070-1500	Transparent liquid	1,500 cSt	Max. 1.5
SiSiB® PF1070-2000	Transparent liquid	2,000 cSt	Max. 1.5
SiSiB® PF1070-3500	Transparent liquid	3,500 cSt	Max. 1.5
SiSiB® PF1070-5000	Transparent liquid	5,000 cSt	Max. 1.5
SiSiB® PF1070-10000	Transparent liquid	10,000 cSt	Max. 1.5
SiSiB® PF1070-20000	Transparent liquid	20,000 cSt	Max. 1.5
SiSiB® PF1070-50000	Transparent liquid	50,000 cSt	Max. 1.5
SiSiB® PF1070-80000	Transparent liquid	80,000 cSt	Max. 1.5
SiSiB® PF1070-100K	Transparent liquid	100,000 cSt	Max. 1.5
SiSiB® PF1070-150K	Transparent liquid	150,000 cSt	Max. 1.5
SiSiB® PF1070-300K	Transparent liquid	300,000 cSt	Max. 1.5
SiSiB® PF1070-1000K	Transparent liquid	1,000,000 cSt	Max. 1.5

RTV silicone sealants are often defined and characterized by their modulus - high, medium, and low. The following guidelines are generally employed in the formulation of each type.

High modulus	Use low viscosity silanol polymer, high fumed silica or treated fumed silica, and tetra- or greater functionality crosslinker.
Medium modulus	Use medium to high viscosity silanol polymer, medium to high silica levels, calcium carbonate and silicone plasticizer.
Low modulus	Use high viscosity silanol polymer, polymer chain extenders (the silanol polymer is chain extended which decreases the crosslinking density), zero to low silica levels, high calcium carbonate level, and silicone plasticizer.

SiSiB SILICONES

OH POLYMER

SILICONE OIL

CATALYST

FUMED SILICA

CROSSLINKER

ADHESION PROMOTER

PLASTICIZER

SiSiB noncreative silicone oils (e.g., polydimethyl silicone) are used in RTV silicone formulations as plasticizers and to improve extrudability of the resulting paste.

They are clear, colorless, odorless and essentially inert. SiSiB Pure Silicone fluids have excellent thermal stability and can be used in open system baths that range from - 40°C to 200°C without breaking down (gelling). In closed systems, their thermal stability is even higher. Silicone fluids possess high dielectric properties and are non-conductive.

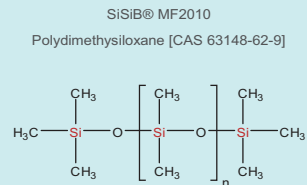

Product	Viscosity cSt	Flashpoint °C	Freezing Point °C	Specific Gravity 25°C	Surface Tension mN/m, 25°C	Refractive Index 25°C
MF2010-50	50	>280	-55	0.959	20.7	1.402
MF2010-100	100	>280	-55	0.965	20.9	1.403
MF2010-200	200	>300	-50	0.967	21.0	1.403
MF2010-250	250	>300	-50	0.970	21.1	1.403
MF2010-350	350	>300	-50	0.970	21.1	1.403
MF2010-500	500	>300	-50	0.970	21.1	1.403
MF2010-1000	1000	>300	-50	0.970	21.2	1.403

The organofunctional group of the silane can react, and bond to, the polymer backbone. Residual moisture activates the silane's alkoxy groups to the active silanol form which react with each other, liberating moisture, and forming siloxane bonds between the polymers. The resulting Si-O-Si crosslink is extremely durable, offering excellent weather, UV, temperature, chemical and moisture resistance.

The cross-linking agent used in RTV silicone systems consists of a species that can be represented as R-Si-X3 (typically used in one-component systems) or Si-X4 (typically used in two-component systems). The R is an organic group such as a methyl, ethyl, or vinyl, phenyl, and the X is a moisture hydrolysable group. A simplified cure mechanism for a one-component silicone RTV sealant is show below:

Figure A: Reaction of crosslinker with polymer ends:

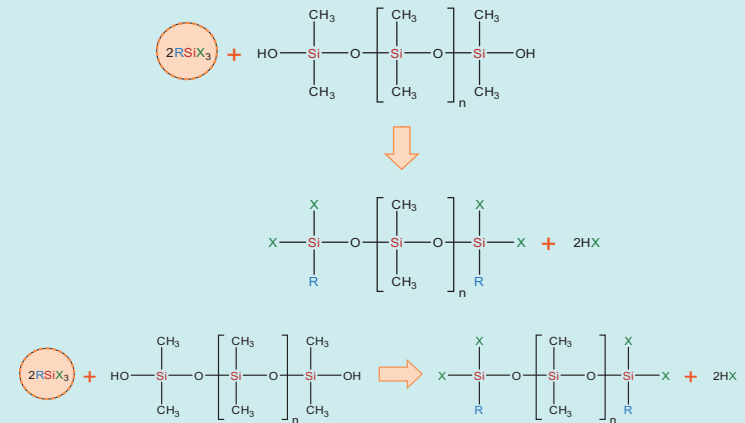

CROSSLINKER



Figure B: Reaction of crosslinker-capped polymer end with moisture:

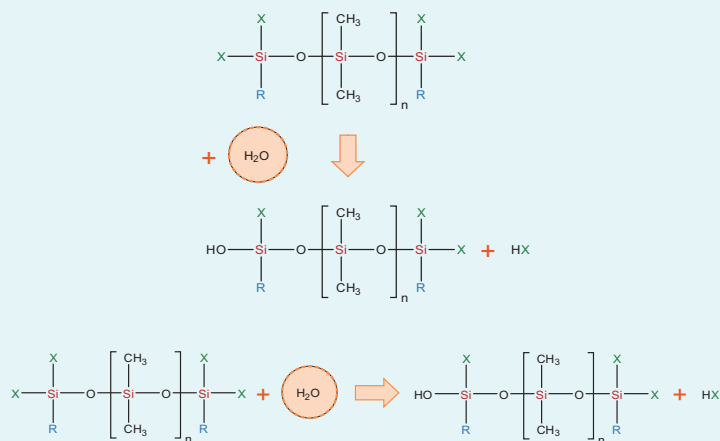
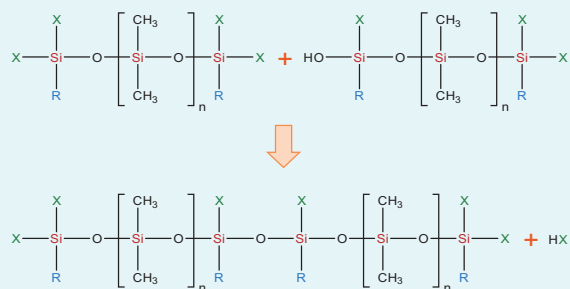

Figure C: Reaction of resultant polymer end with another polymer:



Repeated hydrolysis and reaction of resultant polymer end groups lead to full cure with elimination of HX as a by-product of the condensation reaction.

The acetoxy cure system is the most common RTV system, and it has been used for the longest period of time. However, the by-product is acetic acid, and this could be corrosive to metal substrates or undesirable because of the odor. The alkoxy cure systems produce a by-product that is noncorrosive and has an objectionable odor. The acetoxy, alkoxy, and oxime chemistries are all prevalent today. The characteristic of these cure systems are summarized in table below:

Characteristics of Various RTV silicone Cure Systems

RTV cure system	Characteristics
Acetoxy	Relatively fast cure time and short tack-free time. Good adhesion.
Alkoxy	Longer tack-free time and slower cure than acetoxy. By-product produced is noncorrosive and without objectionable odor. Adhesion is not as good as acetoxy.
Oxime	Low corrosion behavior but somewhat longer tack-free and cure times than acetoxy or alkoxy.

In one component systems, the crosslinker is added to filled polymer and immediately reacts with the polymer as indicated in figure A. The reaction results in the formation of two moisture-hydrolysable reactive sites at each end of every polymer chain. Once reacted in such a manner, the product is ready for packaging. It must be kept away from moisture or moisture vapor to avoid the subsequent curing steps and to provide long shelf life.

Once applied and exposed to ambient moisture, two adjacent polymer chains will react through the hydrolysable reactive sites as show in figure B. The cross-linking will continue until all cross-link sites have been completely consumed. The resulting molecule is a highly cross-linked network with good elasticity.

The cure of a RTV two-component silicone sealant occurs in a similar manner. Most often an alkoxy cross-linking agent and a catalyst are packaged together leaving the siloxane as the second part. A reactive metal catalyst such as dibutyl tin dilaurate is generally used to begin the curing reaction. The components must, of course, be kept dry to provide adequate shelf life. Once the two components are mixed, the hydrolysis reaction begins. After this occurs, the cross-linking reaction may be accelerated by exposure to slightly elevated temperatures.

Cross-linking of either one-component or two component RTV silicone systems at room temperature may be accelerated by the use of catalysts at low levels. The catalyst is usually a tin octoate or dibutyl tin dilaurate. The rate of crosslinking is a function of catalyst concentration and its chemical nature. Catalyzed systems are especially useful in forming a quick dry skin that is often desirable in outdoor application where the weather and elements cannot be controlled.

SiSiB has been developing and producing crosslinkers and coupling agents for the sealant industry for over twenty-five years, supplying world markets with a successful range of innovative products.

Acetoxy Silane Crosslinker	Oximine Silane Crosslinker	Alkoxy Silane Crosslinker
SiSiB® PC7930 MTA	SiSiB® PC7130 MOS	SiSiB® PC5131 MTMS
SiSiB® PC7950 ETA	SiSiB® PC7220 DMOS	SiSiB® PC5132 MTES
SiSiB® PC7960 VTA	SiSiB® PC7500 VOS	SiSiB® PC5420 TEOS
SiSiB® PC7970 PTA	SiSiB® PC7400 TOS	SiSiB® PC5424 TEOS-40
SiSiB® PM2080	SiSiB® PC7600 POS	SiSiB® PC5430 TPOS
SiSiB® PM3070	SiSiB® PC7133 Methyl MIBKO Silane	SiSiB® PC6110 VTMO
SiSiB® PM7030	SiSiB® PC7530 Vinyl MIBKO Silane	SiSiB® PC6151 Enoxy
SiSiB® EM7030	SiSiB® PC7410 Tetra MIBKO silane	SiSiB® PC8151 Enoxy
	SiSiB® PC7131 Methyl Acetoxime Silane	
	SiSiB® PC7531 Vinyl Acetoxime Silane	
	SiSiB® PC7160 Methyl 2-PO Silane	
	SiSiB® PC7560 Vinyl 2-PO Silane	
	SiSiB® MT9010 / MT8515 / MT8020	
	SiSiB® MV6733 / MV8020	
	SiSiB® VT5545 / VT6535 / VT8020 / VT8515	

SiSiB® PC7130 [CAS 22984-54-9]

Methyltris(methylethylketoxime)silane(MOS)

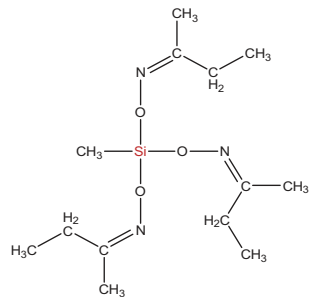

SiSiB® PC7500 [CAS 2224-33-1]

Vinyltris(methylethylketoxime)silane (VOS)

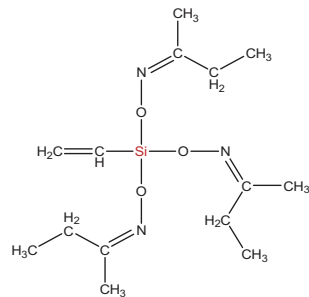

SiSiB® PC7400 [CAS 34206-40-1]

Tetra(methylethylketoxime)silane in toluene (TOS in toluene)

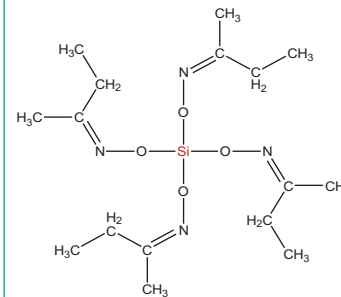

SiSiB® PC7410 [CAS 156145-62-9]

Tetra(methylisobutylketoxime)silane

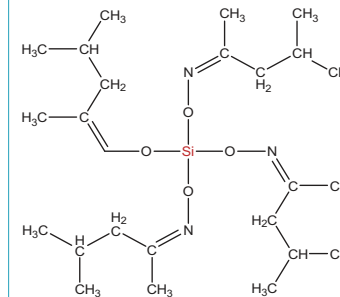

SiSiB® PC7131 [CAS 2594-75-4]

Methyltris(acetoxime)silane

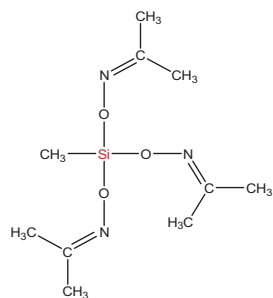

SiSiB® PC7531

Vinyltris(acetoxime)silane

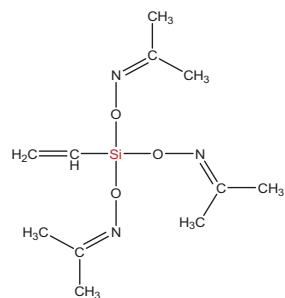

SiSiB® PC7150 [CAS 17898-75-8]

Methyltris(ethyl lactato)silane

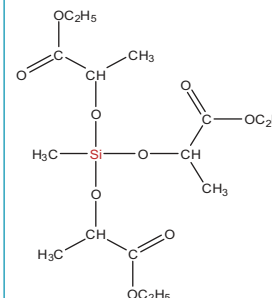

SiSiB® PC7550 [CAS 1124196-01-5]

Vinyltris(ethyl lactato)silane

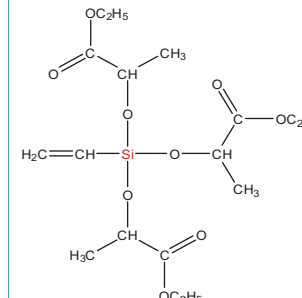

SiSiB® PC7133 [CAS 37859-57-7]

Methyltris(methylisobutylketoxime)silane

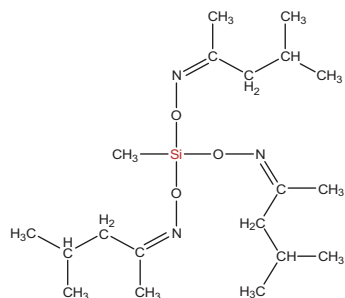

SiSiB® PC7530 [CAS 156145-64-1]

Vinyltris(methylisobutylketoxime)silane

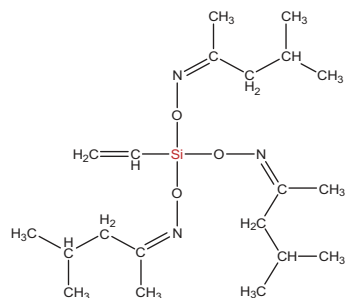

SiSiB® PC7160 [CAS 37859-55-5]

Methyltris(2-pentanoneoxime)silane

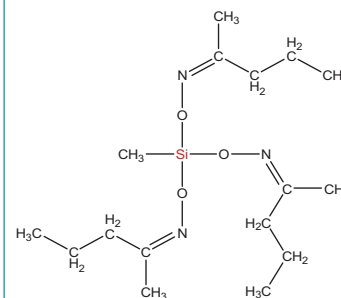

SiSiB® PC7560 [CAS 58190-62-8]

Vinyltris(2-pentanoneoxime)silane

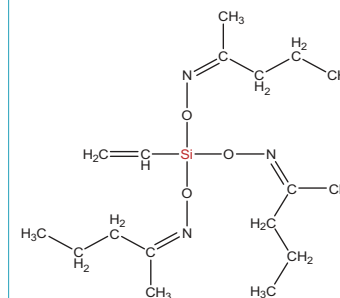

CROSSLINKER

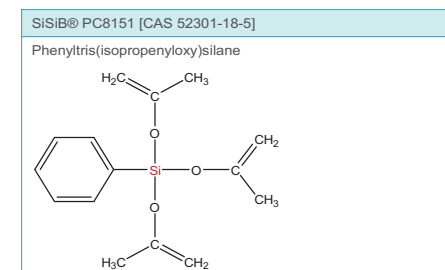
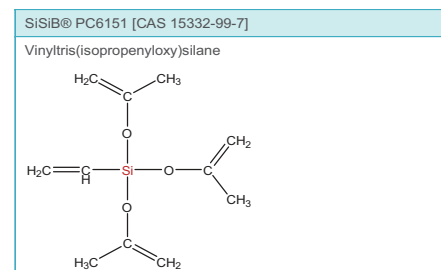
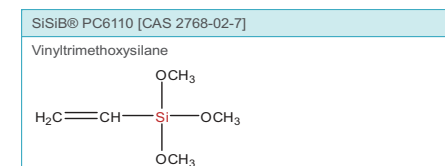
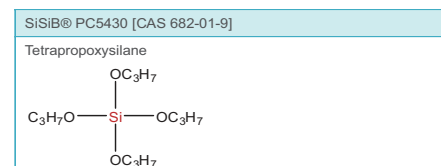
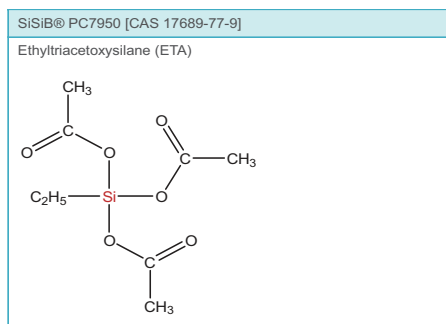
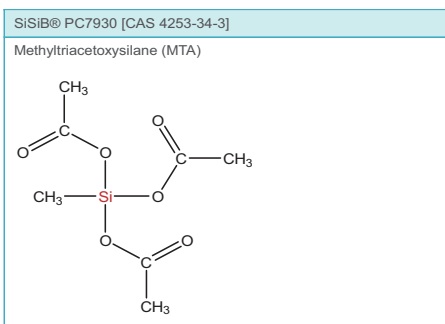
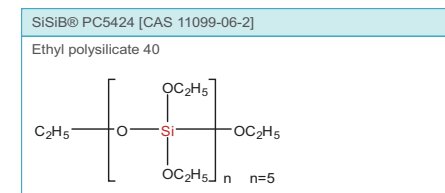
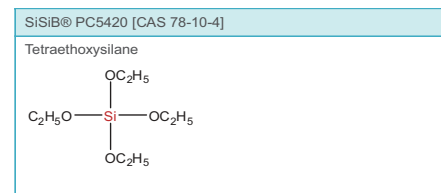
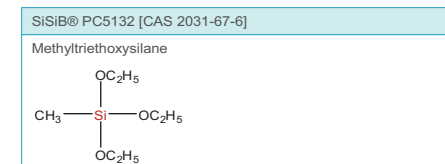
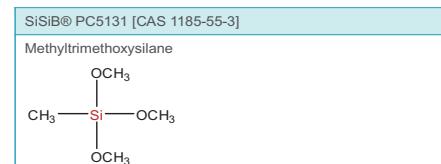
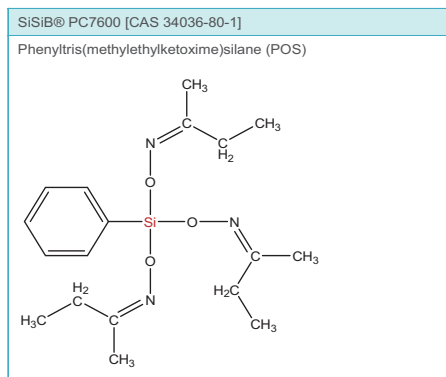
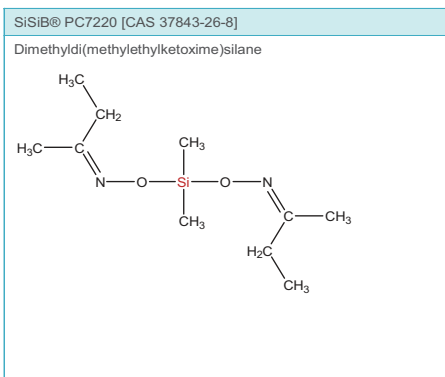
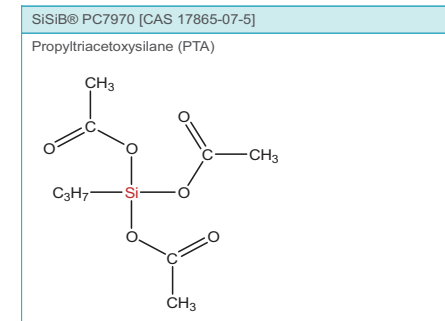
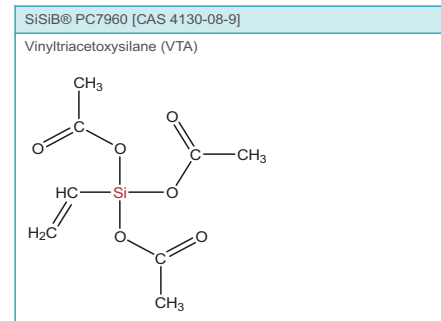
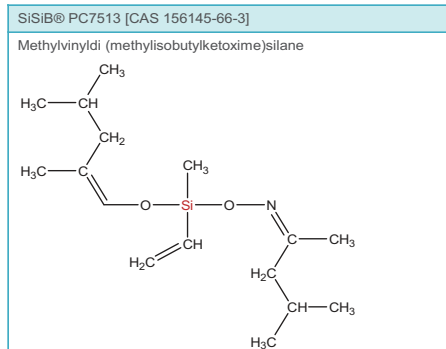
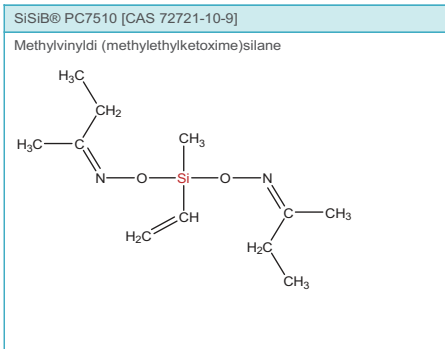

SiSiB SILICONES

BASE POLYMER

PLASTICIZER

CROSSLINKER

FUMED SILICA

CATALYST

ADHESION PROMOTER

Silane Coupling Agent, as a bifunctional organosilicon compound, can be used as an adhesion promoter. It will provide a chemical bond or interaction between a silicone sealant and the inorganic or organic substrate. For adhesion promotion, Silane Coupling Agent can be used directly as an additive in the production of a RTV-1 Silicone Sealants.

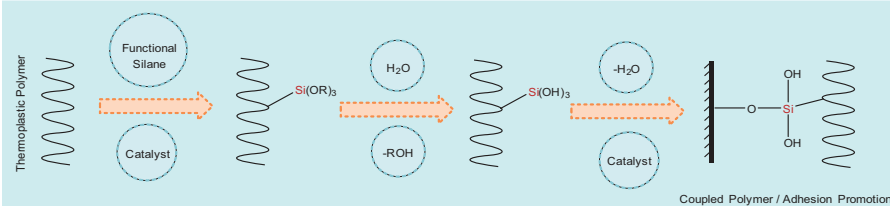

Product	Chemical Name	CAS No.
SiSiB® PC1100	3-Aminopropyltriethoxysilane	919-30-2
SiSiB® PC1110	3-Aminopropyltrimethoxysilane	13822-56-5
SiSiB® PC1200	N-2-(Aminoethyl)-3-Aminopropyltrimethoxysilane	1760-24-3
SiSiB® PC1300	Diethylenetriaminopropyltrimethoxysilane	35141-30-1
SiSiB® PC3100	3-Glycidoxypropyltrimethoxysilane	2530-83-8
SiSiB® AP1280	Oligomeric diamino-silane	N.A.
SiSiB® PC7910	Di-tertbutoxy-diacetoxysilane	13170-23-5

SiSiB® PC1100 [CAS 919-30-2]

3-Aminopropyltriethoxysilane

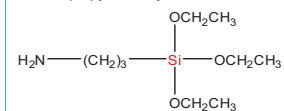

SiSiB® PC1110 [CAS 13822-56-5]

3-Aminopropyltrimethoxysilane

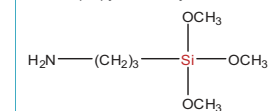

SiSiB® PC1200 [CAS 1760-24-3]

N-(2-Aminoethyl)-3-Aminopropyltrimethoxysilane

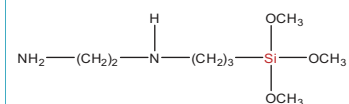

SiSiB® PC1300 [CAS 35141-30-1]

N-(3-trimethoxysilylpropyl)diethylenetriamine

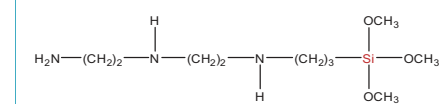

SiSiB® PC3100 [CAS 2530-83-8]

3-Glycidoxypropyltrimethoxysilane

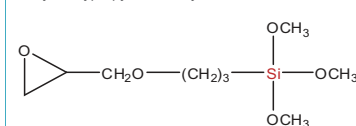

SiSiB® PC7910 [CAS 13170-23-5]

Di-tertbutoxy-diacetoxysilane

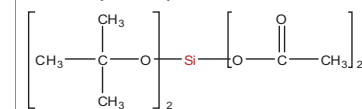

ADHESION
PROMOTER

BASE POLYMER

CROSSLINKER

PLASTICIZER

FUMED SILICA

CATALYST

FUMED SILICA

Fumed silica is used as thixotropic reinforcing agents, adjustments of viscosity and mechanical properties.

Silica filled RTV silicones can be pigmented to any desired color, and this is often required because the cured silicone cannot be painted. Typical pigments are titanium dioxide, carbon black, and a wide variety of metal oxides, chromates, sulfates, etc.

SiSIB provides both hydrophobic and hydrophilic type fumed silica.

Product	Type	Treated by	Specific surface area (BET) m ² /g
SiSIB® FS0150	Hydrophilic	Untreated	150
SiSIB® FS0200	Hydrophilic	Untreated	200
SiSIB® FS2110	Hydrophobic	PDMS	110 (After treatment)
SiSIB® FS5115	Hydrophobic	DDS	115 (After treatment)
SiSIB® FS5170	Hydrophobic	DDS	170 (After treatment)
SiSIB® FS9160	Hydrophobic	HMDS	160 (After treatment)
SiSIB® FS9260	Hydrophobic	HMDS	260 (After treatment)

CATALYST

PowerCat DBTDL and PowerCat DBTDA are used to cure the network and control the rate of cure.

Cross-linking of either one-component or two component RTV silicone systems at room temperature may be accelerated by the use of catalysts at low levels.

The catalyst is usually a tin octoate or dibutyl tin dilaurate.

The rate of crosslinking is a function of catalyst concentration and its chemical nature.

Catalyzed systems are especially useful in forming a quick dry skin that is often desirable in outdoor application where the weather and elements cannot be controlled.

PowerCat™ DBTDL [CAS 77-58-7]

Dibutyltin Dilaurate

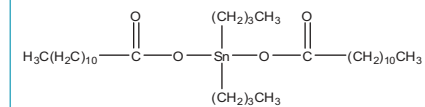

PowerCat™ DBTDA [CAS 1067-33-0]

Dibutyltin Dilaurate

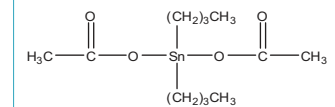

SiSiB SILICONES

BASE POLYMER

PLASTICIZER

CROSSLINKER

FUMED SILICA

CATALYST

START FORMULATION

GENERAL PURPOSE ACETOXY SILICONE SEALANT

Product	Component	Dosage
Base Polymer	SiSiB® PF1070 OH Polymer 80,000cSt	60-80%
Plasticizer	SiSiB® MF2010 Silicone Fluid 1,000cSt	10-20%
Crosslinker	SiSiB® PC7930 MTAS /PC7970 PTAS	5-10%
Catalyst	PowerCat™ DBTDL Dibutyltindilaurate	0.2-1%
Filler	SiSiB® FS0150 Fumed Silica	10%
Adhesion Promoter	SiSiB® PC7910 BDAC	

ALL WEATHER PURPOSE NEUTRAL SILICONE SEALANT

Product	Component	Dosage
Base Polymer	SiSiB® PF1070, Silanol Polymer 80,000 cSt	30-40%
Plasticizer	SiSiB® MF2010, Silicone Fluid 100 cSt	5-10%
Filler	Third party coated calcium carbonate	40-50%
Crosslinker	SiSiB® PC7130 MOS, PC7500 VOS	3-4%
Catalyst	PowerCat™ DBTDL, Dibutyltindilaurate	0.2-1.0%
Adhesion Promoter	SiSiB® PC1100, PC1110, PC1200 or AP1280	

SiSiB SILICONES

BASE POLYMER

PLASTICIZER

CROSSLINKER

FUMED SILICA

CATALYST